

NOVELTIES

2021



Nowodvorski
LIGHTING

Light for your home
Since 1994

Nowodvorski
LIGHTING



PEAR S
8673 TR/G

PEAR L
8671 TR/G

PEAR M
8672 TR/G





AMALFI L
8381 G

AMALFI L 8380 SI



AMALFI L 8381 G

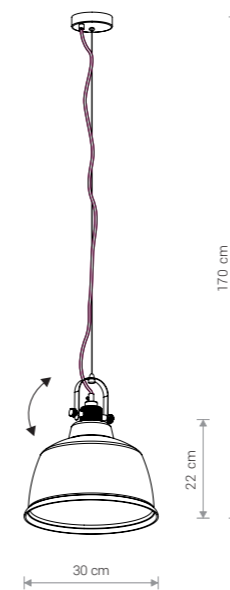

AMALFI L

szkło metalizowane, stal lakierowana, mosiądz /
metallized glass, painted steel, brass /
металлизированное стекло, лакированная сталь, латунь

8380 ● SI 8381 ● G

⚡ 1×E27, max 40W



HAMPTON 8154 CH/TR

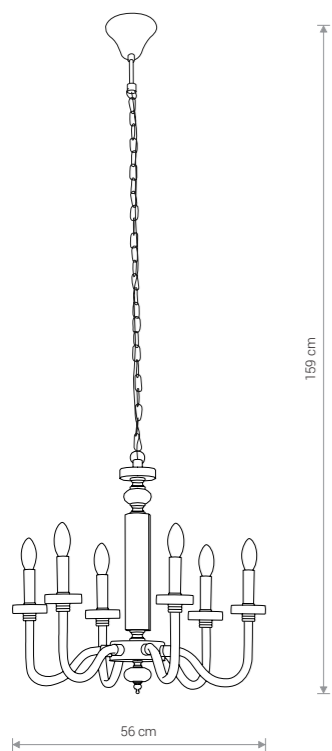

HAMPTON

szkło, stal chromowana / glass, electroplated steel /
стекло, хромированная сталь

8154 CH/TR

6×E14, max 40W



HAMPTON 8155 CH/TR

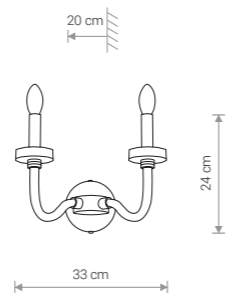

HAMPTON

szkło, stal chromowana / glass, electroplated steel /
стекло, хромированная сталь

8155 CH/TR

2×E14, max 40W



BOSTON 8153 CH/TR

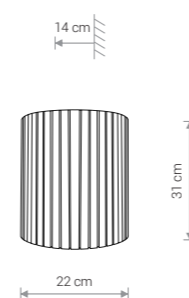

BOSTON

szkło, stal chromowana / glass, electroplated steel /
стекло, хромированная сталь

8153 CH/TR

1×E14, max 40W

BOSTON 8152 CH/TR

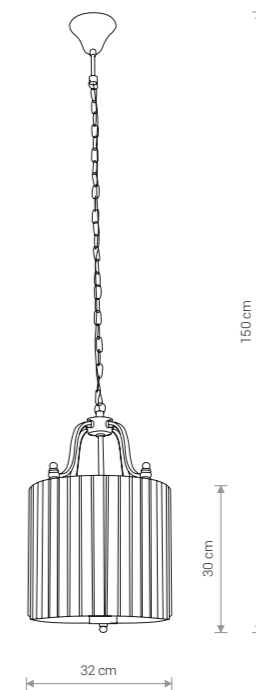

BOSTON

szkło, stal chromowana / glass, electroplated steel /
стекло, хромированная сталь

8152 CH/TR

4×E14, max 40W

NUNTUCET 8150 CH/WH



NUNTUCET 8151 CH/WH

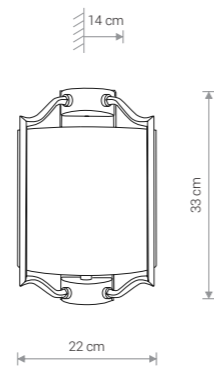
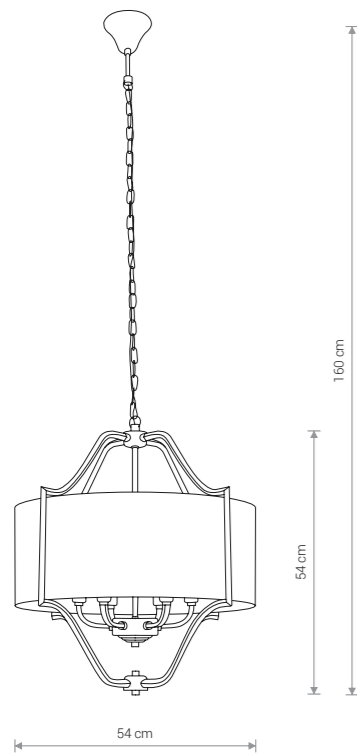

NUNTUCET

stal chromowana, abażur / electroplated steel, shade /
хромированная сталь, абажур

8150 CH/WH

6×E14, max 40W

NUNTUCET

stal chromowana, abażur / electroplated steel, shade /
хромированная сталь, абажур

8151 CH/WH

1×E14, max 40W

NEWPORT 8156 WH



NEWPORT 8157 WH

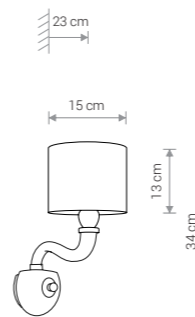

NEWPORT

szkło, stal chromowana, abażur /
glass, electroplated steel, shade /
стекло, хромированная сталь, абажур

8157 WH

1×E14, max 40W

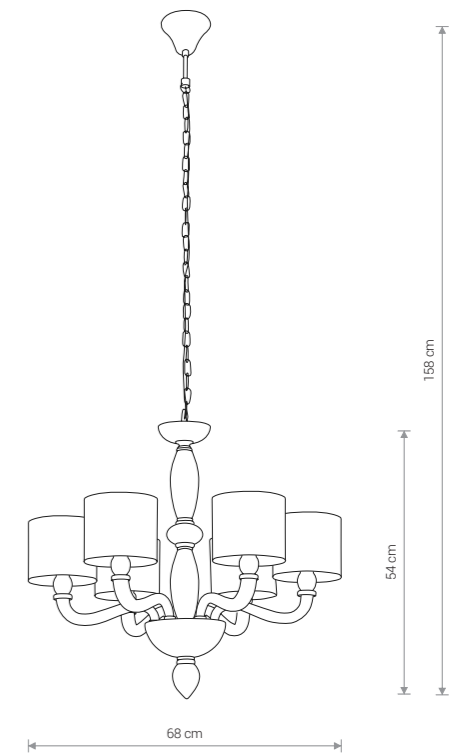

NEWPORT

szkło, stal chromowana, abażur /
glass, electroplated steel, shade /
стекло, хромированная сталь, абажур

8156 WH

6×E14, max 40W



LASER 750 8433 BL



LASER 750
8432 WH

LASER 750
8431 BS

LASER 750
8433 BL

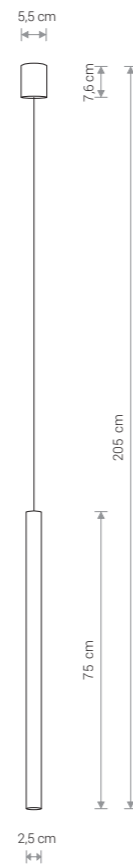

LASER 750

stal lakierowana / painted steel /
лакированная сталь

8432 ○ WH 8433 ● BL

Ⓛ 1×G9, max 10W, only LED

mosiądz / solid brass / латунь

8431 ● BS

Ⓛ 1×G9, max 10W, only LED

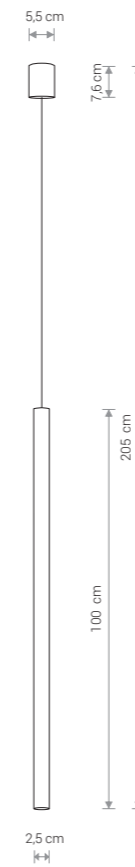

LASER 1000

stal lakierowana / painted steel /
лакированная сталь

8435 ○ WH 8436 ● BL

Ⓛ 1×G9, max 10W, only LED

mosiądz / solid brass / латунь

8434 ● BS

Ⓛ 1×G9, max 10W, only LED



LASER 1000
8435 WH

LASER 1000
8434 BS

LASER 1000
8436 BL



STALACTITE 8355 BL



STALACTITE 8354 WH



STALACTITE 8352 BS/BL

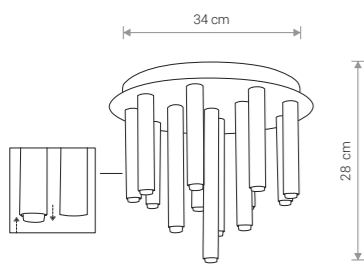

STALACTITE

stal lakierowana / painted steel /
лакированная сталь

8355 ● BL 8356 ○ WH

Ⓢ 13×G9, max 10W, only LED

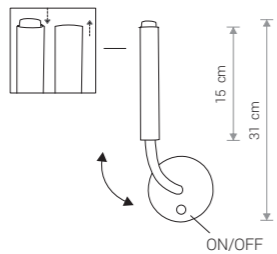

STALACTITE

stal lakierowana, peszel /
painted steel, protective pipe /
лакированная сталь, кабель-канал

8350 ○ WH 8351 ● BL

Ⓢ 1×G9, max 10W, only LED

mosiądz, stal lakierowana, peszel /
brass, painted steel, protective pipe /
латунь, лакированная сталь, кабель-канал

8352 ● BS/BL

Ⓢ 1×G9, max 10W, only LED

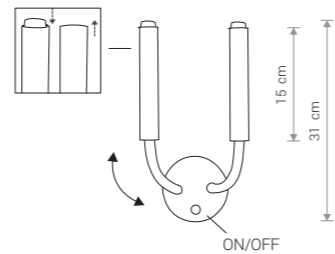

STALACTITE

stal lakierowana, peszel /
painted steel, protective pipe /
лакированная сталь, кабель-канал

8354 ○ WH 8353 ● BL

Ⓢ 2×G9, max 10W, only LED

mosiądz, stal lakierowana, peszel /
brass, painted steel, protective pipe /
латунь, лакированная сталь, кабель-канал

9055 ● BS/BL

Ⓢ 2×G9, max 10W, only LED



STALACTITE 9055 BS/BL



GSTAR 8285 G/BL



22 cm

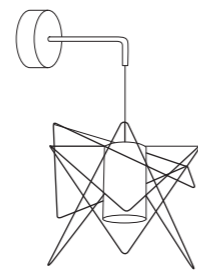

36 cm

25 cm

GSTAR

stal lakierowana, stal mosiądzowana /
 painted steel, electroplated brass /
 лакированная сталь, латунная сталь

8285 G/BL

1×GU10, max 10W, only LED



WHEEL LUX 8428 BL



WHEEL LUX 8427 G



WHEEL LUX 8430 G/BL

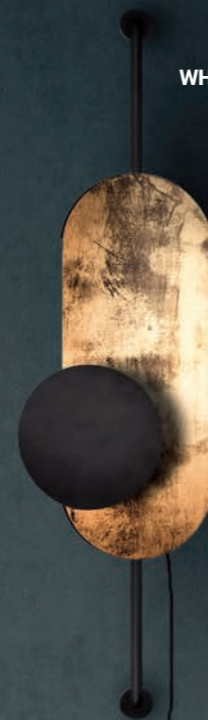

WHEEL LUX 8430 G/BL

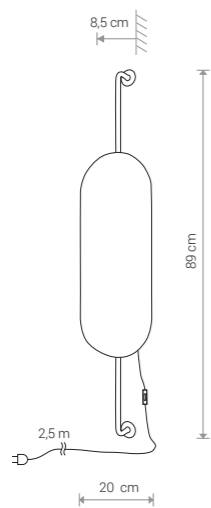
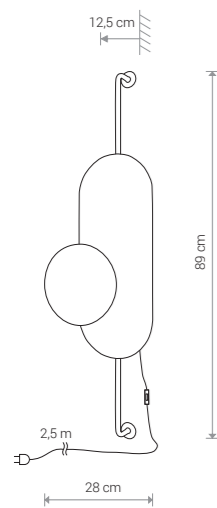

WHEEL LUX

sklejka, stal lakierowana / plywood, painted steel /
дерево, лакирована сталь

8427 ● G 8428 ● BL

Ⓛ 2×G9, max 12W, only LED

sklejka, stal lakierowana / plywood, painted steel /
дерево, лакирована сталь

8430 ● G/BL

Ⓛ 1×G9, max 12W, only LED





BARREL L
8446 V NB/G

BARREL L 8445 V WH



BARREL L 8444 V PI/WH

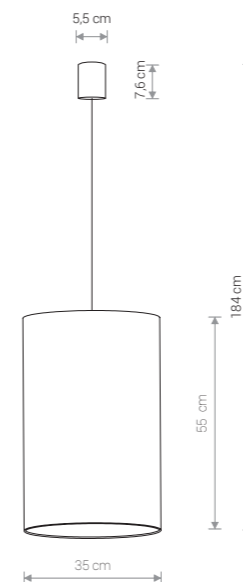

BARREL L

aksamit / velvet / бархат

8444 ● V PI/WH 8446 ● V NB/G 8445 ○ V WH

Ⓛ 1×E27, max 60W

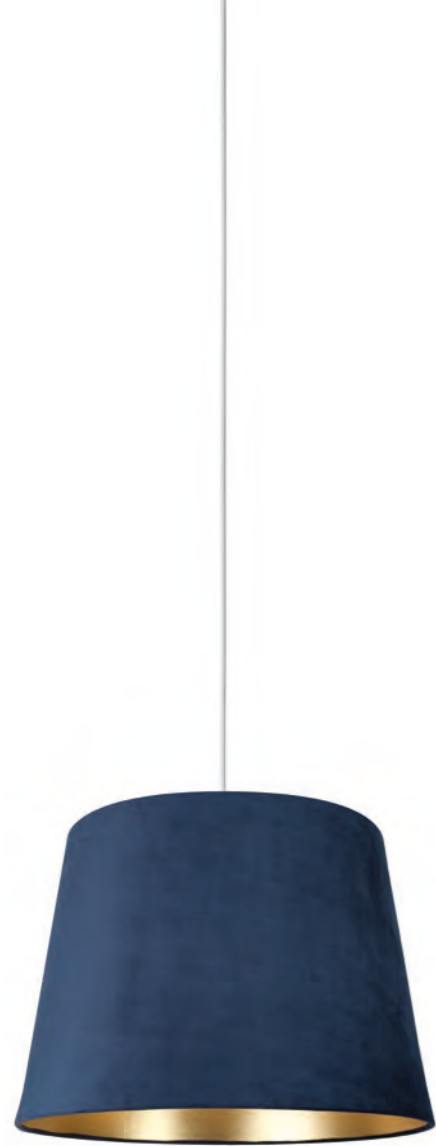

CONE M 8443 V NB/G



CONE M 8442 V WH



CONE M 8441 V PI/WH



CONE L 8438 V WH



CONE L 8437 V PI/WH



CONE L 8440 NB/G

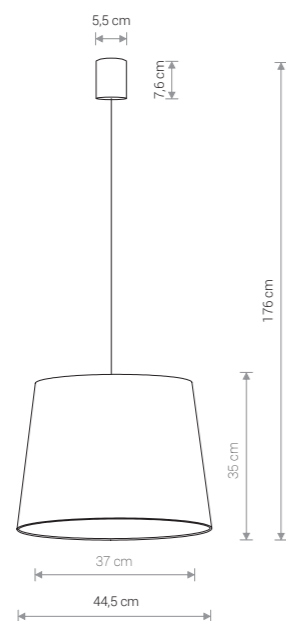

CONE M

aksamit / velvet / бархат

8441 V PI/WH 8443 V NB/G 8442 V WH

1×E27, max 60W

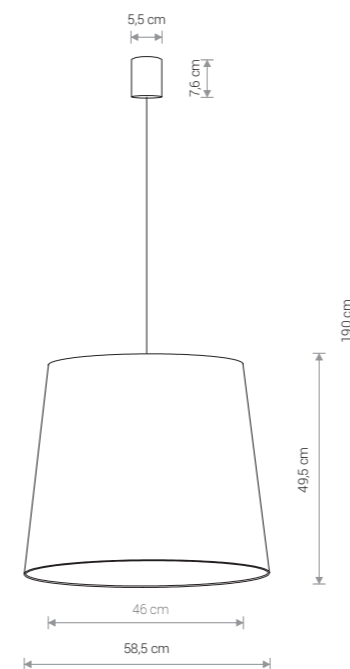

CONE L

aksamit / velvet / бархат

8437 V PI/WH 8440 V NB/G 8438 V WH

1×E27, max 60W



PETIT A 8340 V PI/WH

PETIT 8345 WH

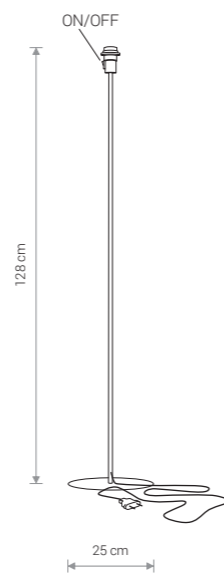
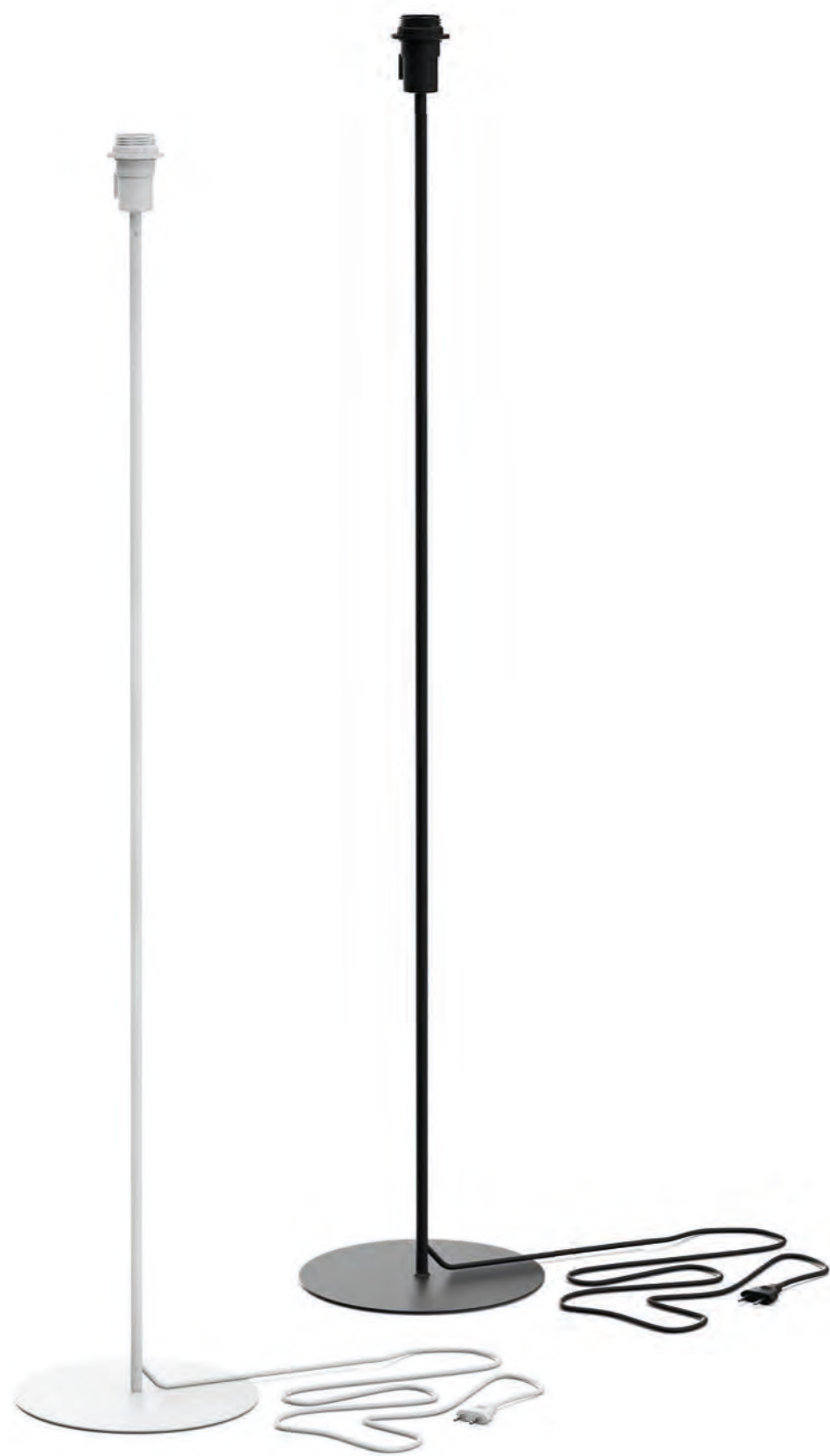

PETIT

stal lakierowana / painted steel /
лакированная сталь

8345 ○ WH 8346 ● BL

Ⓢ 1×E27 max 40W

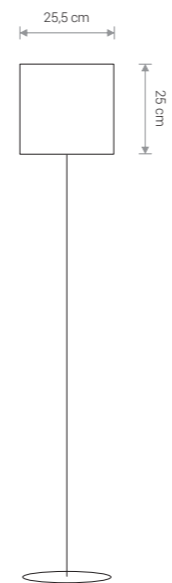

PETIT A

abażur / shade / абажур

8333 ● BL/G 8337 ○ GY 8343 ○ WH 8332 ● GY

8340 ○ V PI/WH 8344 ● V NB/G 8334 ● V GN/G

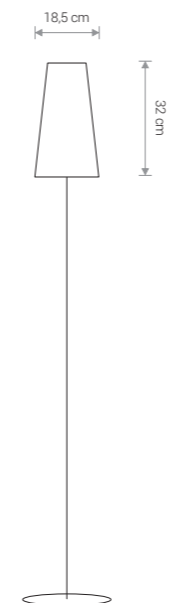

PETIT B

abażur / shade / абажур

8338 ● BL/G 8336 ○ GY 8342 ○ WH

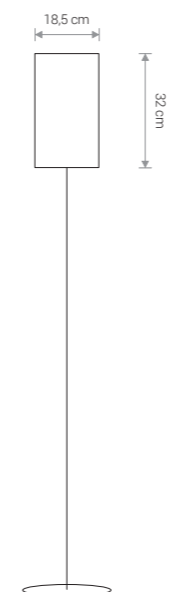

PETIT C

abażur / shade / абажур

8226 ● BL/G 8335 ○ GY 8341 ○ WH



ROCKET 8490 WH



ROCKET 8448 GY

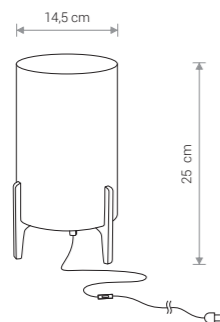

ROCKET

abažur, sklejk / shade, plywood / абажур, дерево

8490 ○ WH 8448 ● GY

1×E27, max 40W



ROCKET 8490 WH



ORGANIC
8303 BL



ORGANIC
8304 WH



ORGANIC
8305 WH



ORGANIC
8302 BL



ORGANIC
8303 BL

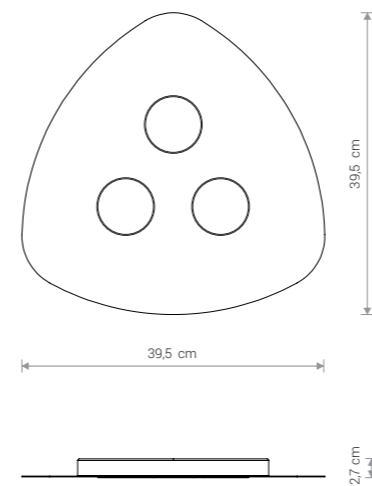

ORGANIC

stal lakierowana / painted steel /
лакированная сталь

8304 ○ WH 8302 ● BL

Ⓢ 3×GX53, max 12W, only LED

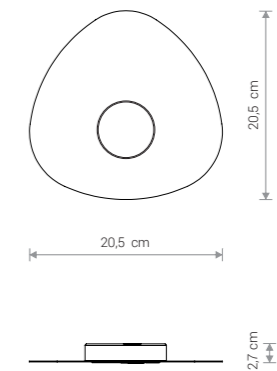

ORGANIC

stal lakierowana / painted steel /
лакированная сталь

8305 ○ WH 8303 ● BL

Ⓢ 1×GX53, max 12W, only LED



FLEA 8203 BL



FLEA 8202 WH

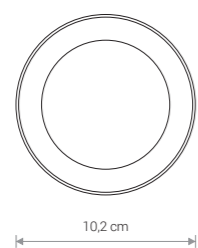
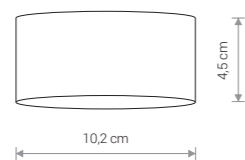

FLEA

stal lakierowana / painted steel /
лакированная сталь

8202 ○ WH 8203 ● BL

Ⓛ 1×GX53, max 12W, only LED



POINT TONE 8222 WH/WH



POINT TONE 8225 BL/BL

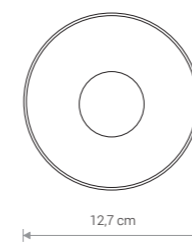
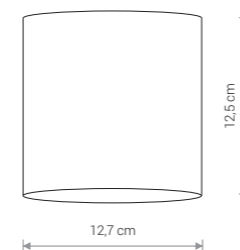
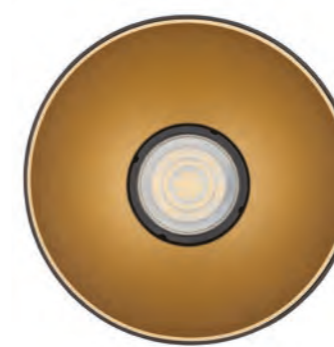

POINT TONE

stal lakierowana, tworzywo sztuczne / painted steel, plastic /
лакированная сталь, пластик

8222 ○ WH/WH 8221 ● WH/G 8220 ○ WH/SI

8225 ● BL/BL 8224 ● BL/G 8223 ● BL/SI

Ⓛ 1×GU10, max 10W, only LED



PROFILE STORE PRO LED 7W
8316 WH



PROFILE STORE PRO LED 7W
8318 BL

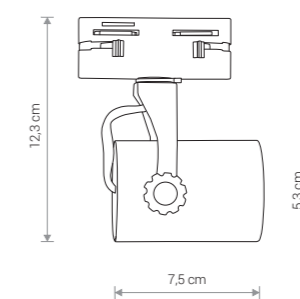
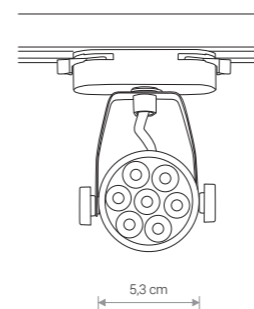

PROFILE STORE PRO LED 7W

aluminium, PC / aluminum, PC / алюминий, PC

8316 ○ WH - 3000K 8318 ● BL - 3000K
8315 ○ WH - 4000K 8317 ● BL - 4000K

Item No.	POWER	COLOUR TEMP.	LUMINOUS FLUX	BEAM ANGLE	COLOUR RENDERING INDEX (CRI ≥)	INPUT	SAFETY TYPE	POWER FACTOR	INGRESS PROTECTION	LIFETIME
8316	7W	3000K	560 lm	24°	80	~220-230V, 50/60Hz	□	0,5	IP20	30 000h
8315	7W	4000K	560 lm	24°	80	~220-230V, 50/60Hz	□	0,5	IP20	30 000h
8318	7W	3000K	560 lm	24°	80	~220-230V, 50/60Hz	□	0,5	IP20	30 000h
8317	7W	4000K	560 lm	24°	80	~220-230V, 50/60Hz	□	0,5	IP20	30 000h



PROFILE STORE PRO LED 12W
8321 WH



PROFILE STORE PRO LED 12W
8323 BL



PROFILE STORE PRO LED 18W
8325 WH



PROFILE STORE PRO LED 18W
8327 BL

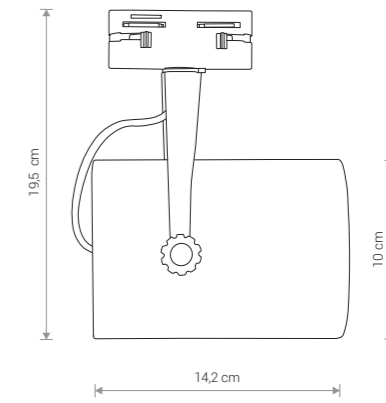
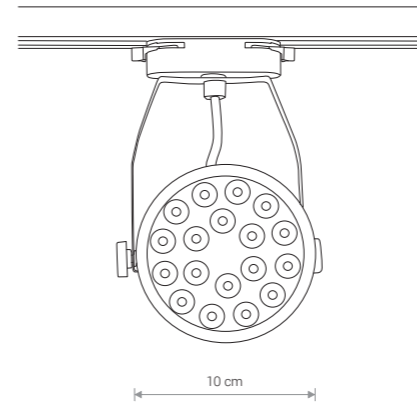
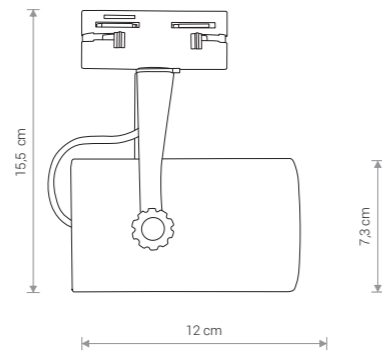
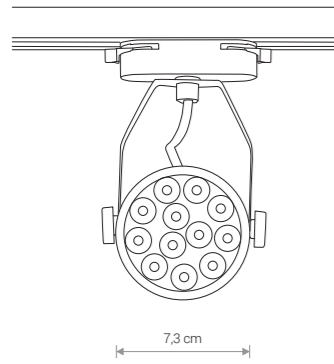

PROFILE STORE PRO LED 12W

aluminium, PC / aluminum, PC / алюминий, PC

8321 ○ WH - 3000K 8323 ● BL - 3000K
8320 ○ WH - 4000K 8322 ● BL - 4000K

Item No.	POWER	COLOUR TEMP.	LUMINOUS FLUX	BEAM ANGLE	COLOUR RENDERING INDEX (CRI ≥)	INPUT	SAFETY TYPE	POWER FACTOR	INGRESS PROTECTION	LIFETIME
8321	12W	3000K	960 lm	24°	80	~220-230V, 50/60Hz	□	0,5	IP20	30 000h
8320	12W	4000K	960 lm	24°	80	~220-230V, 50/60Hz	□	0,5	IP20	30 000h
8323	12W	3000K	960 lm	24°	80	~220-230V, 50/60Hz	□	0,5	IP20	30 000h
8322	12W	4000K	960 lm	24°	80	~220-230V, 50/60Hz	□	0,5	IP20	30 000h

PROFILE STORE PRO LED 18W

aluminium, PC / aluminum, PC / алюминий, PC

8325 ○ WH - 3000K 8327 ● BL - 3000K
8324 ○ WH - 4000K 8326 ● BL - 4000K

Item No.	POWER	COLOUR TEMP.	LUMINOUS FLUX	BEAM ANGLE	COLOUR RENDERING INDEX (CRI ≥)	INPUT	SAFETY TYPE	POWER FACTOR	INGRESS PROTECTION	LIFETIME
8325	18W	3000K	1440 lm	24°	80	~220-230V, 50/60Hz	□	0,5	IP20	30 000h
8324	18W	4000K	1440 lm	24°	80	~220-230V, 50/60Hz	□	0,5	IP20	30 000h
8327	18W	3000K	1440 lm	24°	80	~220-230V, 50/60Hz	□	0,5	IP20	30 000h
8326	18W	4000K	1440 lm	24°	80	~220-230V, 50/60Hz	□	0,5	IP20	30 000h



PROFILE FLEX CONNECTOR
8383 BL

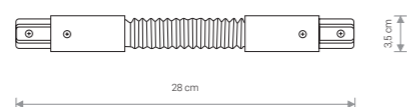

PROFILE FLEX CONNECTOR

PC, miedz / PC, cooper / PC, медь

8382 ○ WH 8383 ● BL

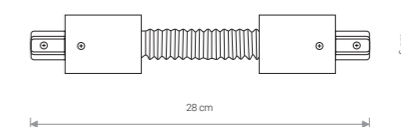

PROFILE RECESSED FLEX CONNECTOR

PC, miedz / PC, cooper / PC, медь

8384 ○ WH 8385 ● BL



STYLE LED 8404 BL

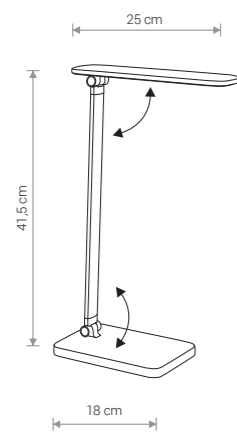

- Indukcyjne ładowanie smartfona (5V 1A)
- Możliwość wyboru temperatury barwowej światła w przedziałach 3000 - 6000K
- Włącznik dotykowy z funkcją ściemniania
- Port USB umożliwiający ładowanie telefonu

- Wireless charger for smartphones (5V 1 A)
- Possibility to choose the colour temperature in the range from 3000K to 6000K
- Touch switch with dimming function
- USB port to charge mobile phones

- Индуктивная зарядка смартфона (5 В, 1 А)
- Возможность выбора температуры света в диапазоне 3000 - 6000К
- Сенсорный переключатель с функцией затемнения
- USB-вход для зарядки телефона.

STYLE LED

aluminium, ABS / aluminium, ABS /
алюминий, ABS

8404 ● BL

Item No.	POWER	COLOUR TEMP.	LUMINOUS FLUX	BEAM ANGLE	COLOUR RENDERING INDEX (CRI ≥)	INPUT	SAFETY TYPE	POWER FACTOR	INGRESS PROTECTION	LIFETIME
8404	10W	3000-6000K	390 lm	100°	80	~220-230V, 50/60Hz	□	0,5	IP20	25 000h



STYLE LED 8404 BL



SMART LED 8358 BL

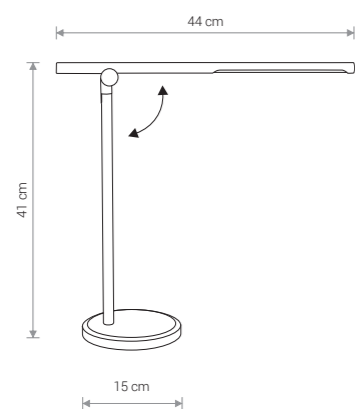

- Możliwość wyboru temperatury barwowej światła w przedziałach 3000 - 6000K
- Włącznik dotykowy z funkcją ściemniania
- Port USB umożliwiające ładowanie telefonu

- Possibility to choose the colour temperature in the range from 3000K to 6000K
- Touch switch with dimming function
- USB port to charge mobile phones

- Возможность выбора температуры света в диапазоне 3000 - 6000K
- Сенсорный переключатель с функцией затемнения
- USB-вход для зарядки телефона

SMART LED

aluminium, ABS / aluminium, ABS /
алюминий, ABS

8358 ● BL

Item No.	POWER	COLOUR TEMP.	LUMINOUS FLUX	BEAM ANGLE	COLOUR RENDERING INDEX (CRI ≥)	INPUT	SAFETY TYPE	POWER FACTOR	INGRESS PROTECTION	LIFETIME
8358	8W	3000-6000K	400 lm	120°	80	~220-230V, 50/60Hz	□	0,5	IP20	25 000h



CHIC LED 8357 SI/BL

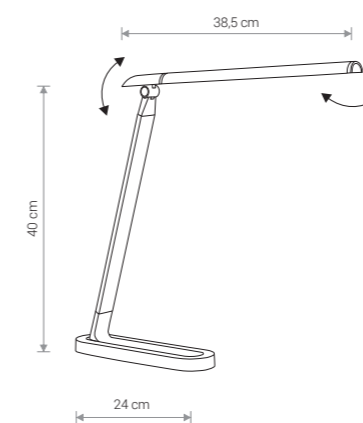

- Włącznik dotykowy z funkcją ściemniania
- Temperatura barwowa światła 4000K

- Touch switch with dimming function
- Colour temperature 4000K

- Сенсорный переключатель с функцией затемнения
- Цветовая температура света 4000K

CHIC LED

aluminium, ABS / aluminium, ABS /
алюминий, ABS

8357 ● SI/BL

Item No.	POWER	COLOUR TEMP.	LUMINOUS FLUX	BEAM ANGLE	COLOUR RENDERING INDEX (CRI ≥)	INPUT	SAFETY TYPE	POWER FACTOR	INGRESS PROTECTION	LIFETIME
8357	7,5W	4000K	400 lm	100°	80	~220-230V, 50/60Hz	□	0,5	IP20	25 000h

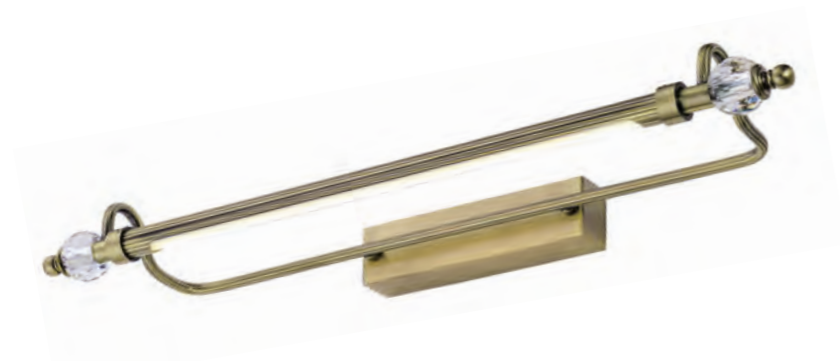

REMBRANT LED M 8166 A/BS



REMBRANT LED L 8167 A/BS

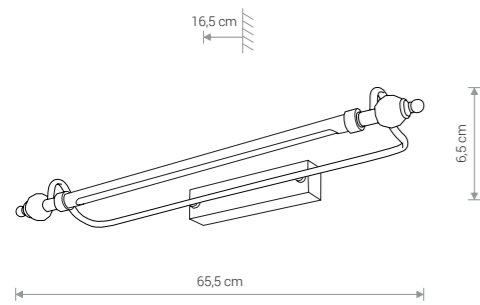

REMBRANT LED M

stal / steel / сталь

8166  A/BS

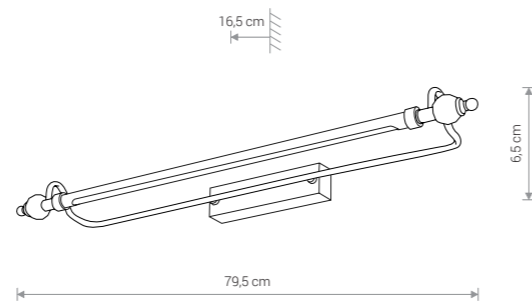

REMBRANT LED L

stal / steel / сталь

8167  A/BS



GIOTTO LED S 8168 A/BS



GIOTTO LED M 8170 A/BS

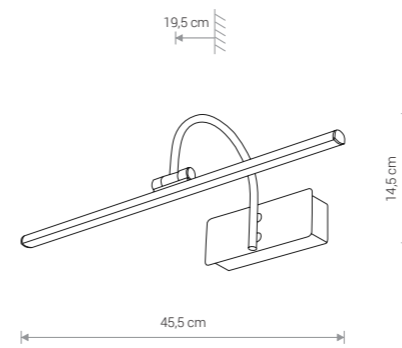

GIOTTO LED S

stal / steel / сталь

8168  A/BS

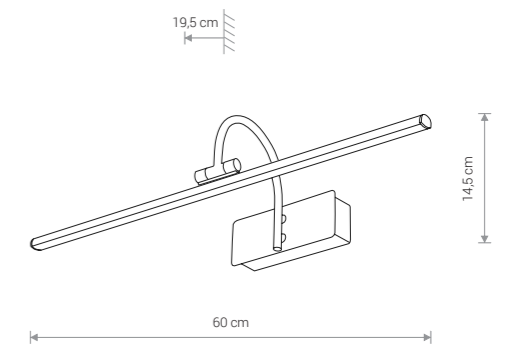

GIOTTO LED M

stal / steel / сталь

8170  A/BS

Item No.	POWER	COLOUR TEMP.	LUMINOUS FLUX	BEAM ANGLE	COLOUR RENDERING INDEX (CRI ≥)	INPUT	POWER FACTOR	SAFETY CLASS	INGRESS PROTECTION	LIFETIME
8166	8W	3000K	600 lm	120°	80	~220-230V, 50/60Hz	0,5	⊕	IP20	30 000h
8167	12W	3000K	700 lm	120°	80	~220-230V, 50/60Hz	0,5	⊕	IP20	30 000h

Item No.	POWER	COLOUR TEMP.	LUMINOUS FLUX	BEAM ANGLE	COLOUR RENDERING INDEX (CRI ≥)	INPUT	POWER FACTOR	SAFETY CLASS	INGRESS PROTECTION	LIFETIME
8168	8W	3000K	420 lm	120°	80	~220-230V, 50/60Hz	0,5	⊕	IP20	30 000h
8170	12W	3000K	570 lm	120°	80	~220-230V, 50/60Hz	0,5	⊕	IP20	30 000h

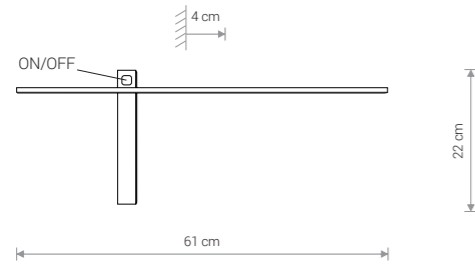

IMPULSE LED S

aluminium, PC / aluminium, PC / алюминий, PC

8115 ● BL

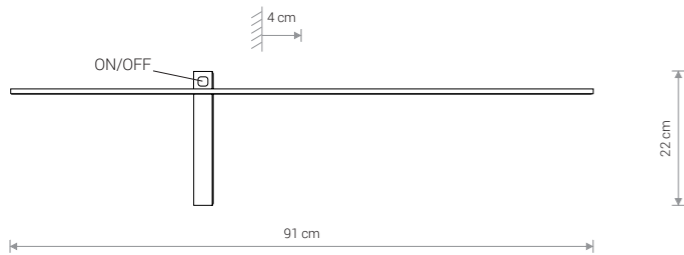
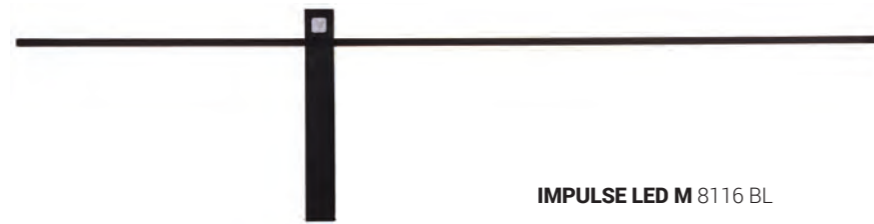

IMPULSE LED M

aluminium, PC / aluminium, PC / алюминий, PC

8116 ● BL

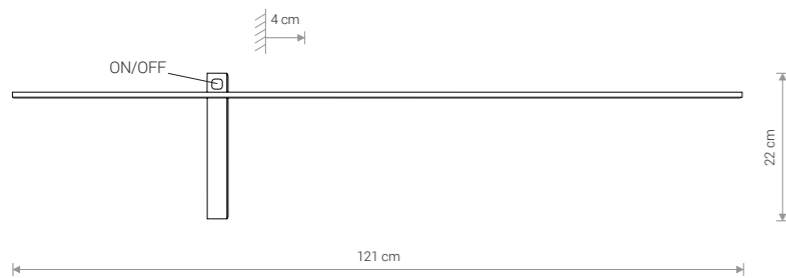
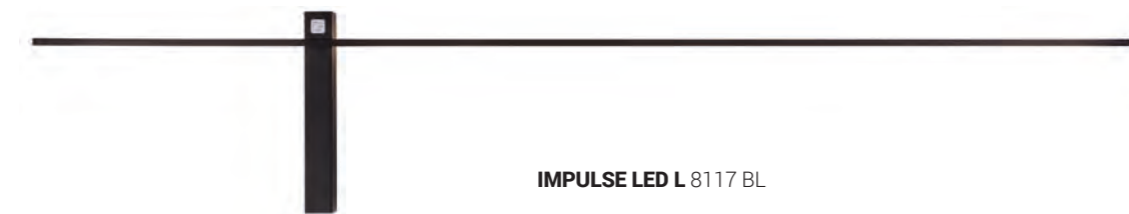

IMPULSE LED L

aluminium, PC / aluminium, PC / алюминий, PC

8117 ● BL

Item No.	POWER	COLOUR TEMP.	LUMINOUS FLUX	BEAM ANGLE	COLOUR RENDERING INDEX (CRI ≥)	INPUT	POWER FACTOR	SAFETY CLASS	INGRESS PROTECTION	LIFETIME
8115	6W	3000K	200 lm	120°	80	~220-230V, 50/60Hz	0,5	□	IP23	30 000h
8116	10W	3000K	350 lm	120°	80	~220-230V, 50/60Hz	0,5	□	IP23	30 000h
8117	15W	3000K	380 lm	120°	80	~220-230V, 50/60Hz	0,5	□	IP23	30 000h

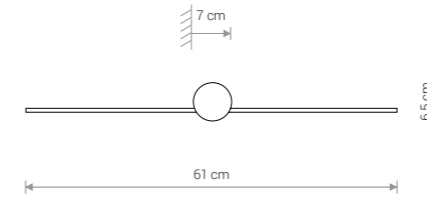
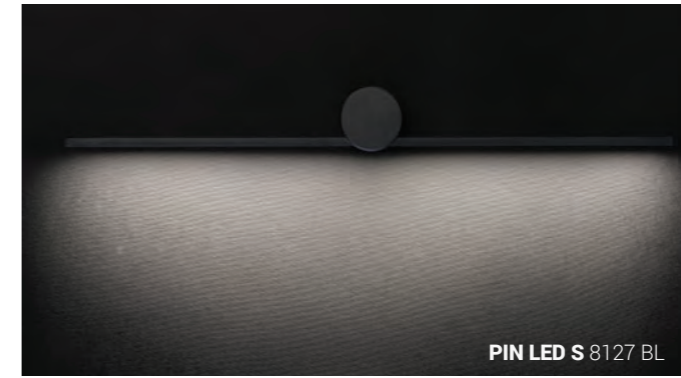

PIN LED S

aluminium, PC / aluminium, PC / алюминий, PC

8127 ● BL



PIN LED M 8128 BL

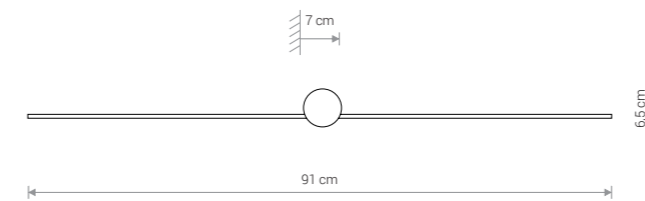

PIN LED M

aluminium, PC / aluminium, PC / алюминий, PC

8128 ● BL



PIN LED L 8130 BL

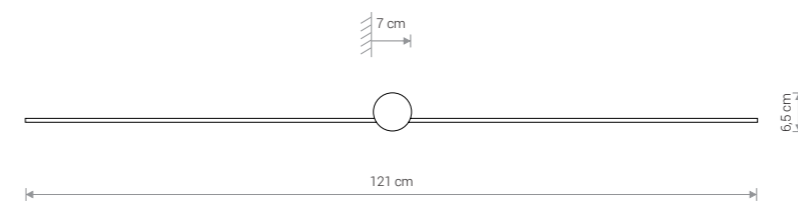

PIN LED L

aluminium, PC / aluminium, PC / алюминий, PC

8130 ● BL

Item No.	POWER	COLOUR TEMP.	LUMINOUS FLUX	BEAM ANGLE	COLOUR RENDERING INDEX (CRI ≥)	INPUT	POWER FACTOR	SAFETY CLASS	INGRESS PROTECTION	LIFETIME
8127	6W	4000K	280 lm	120°	80	~220-230V, 50/60Hz	0,9	□	IP44	30 000h
8128	10W	4000K	500 lm	120°	80	~220-230V, 50/60Hz	0,9	□	IP44	30 000h
8130	15W	4000K	540 lm	120°	80	~220-230V, 50/60Hz	0,9	□	IP44	30 000h



CAYO 8055 BL

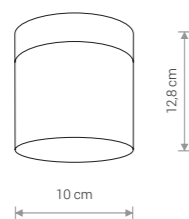

CAYO

stal lakierowana, szkło / painted steel, glass /
лакированная сталь, стекло

8055 ● BL

1×G9, max 25W

IP44

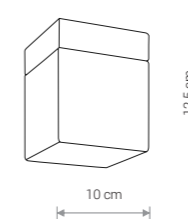

SIS

stal lakierowana, szkło / painted steel, glass /
лакированная сталь, стекло

8054 ● BL

1×G9, max 25W

IP44



ICE BALL 8126 A/BS

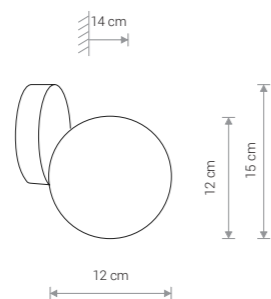

ICE BALL

stal, szkło / steel, glass /
сталь, стекло

8126  A/BS

 1×G9, max 25W

IP44



BALI 8053 BL



BALI

stal lakierowana, szkło / painted steel, glass /
лакированная сталь, стекло

8053 ● BL

1×E14, max 25W

IP44



SIMI

stal lakierowana, szkło / painted steel, glass /
лакированная сталь, стекло

8052 ● BL

1×G9, max 25W

IP44

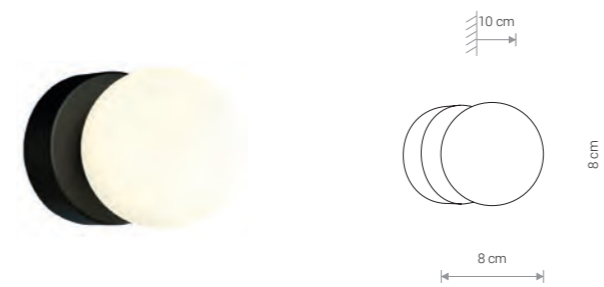

BRAZOS

stal lakierowana, szkło / painted steel, glass /
лакированная сталь, стекло

8057 ● BL

1×G9, max 25W

IP44

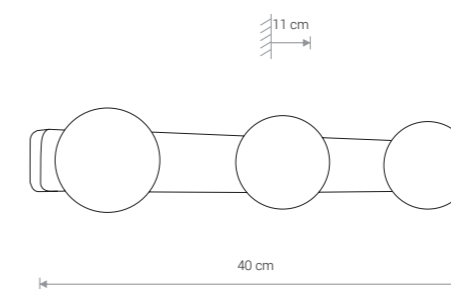

BRAZOS

stal lakierowana, szkło / painted steel, glass /
лакированная сталь, стекло

8056 ● BL

3×G9, max 25W

IP44



ICE EGG B 8125 BL

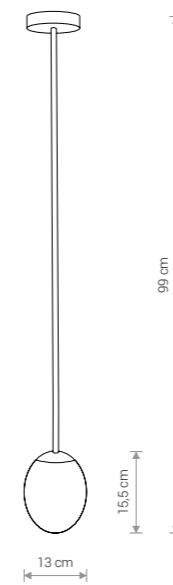

ICE EGG A

stal lakierowana, szkło / painted steel, glass /
лакированная сталь, стекло

8124 ● BL

1×G9, max 25W

IP44

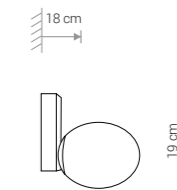

ICE EGG C

aluminium, szkło / aluminium, glass /
алюминий, стекло

8132 ● BL

1×G9, max 25W

IP44

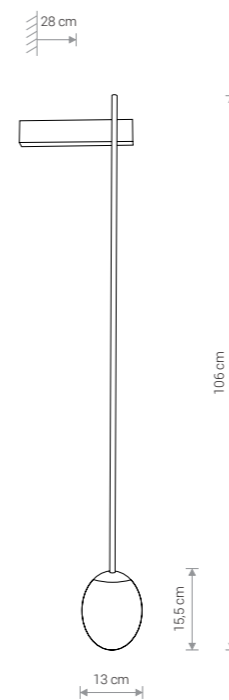

ICE EGG B

stal lakierowana, szkło / painted steel, glass /
лакированная сталь, стекло

8125 ● BL

1×G9, max 25W

IP44

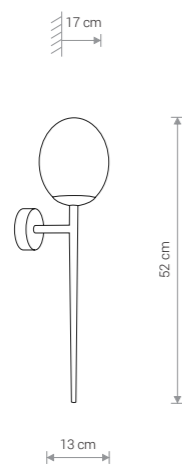

TORCH

stal chromowana, szkło / electroplated steel, glass /
хромированная сталь, стекло

8123 ● CH

1×G9, max 25W

IP44



ION LED M 8171 CH

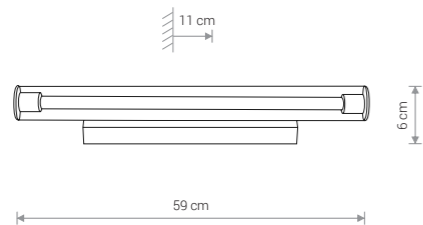

ION LED M

szkło, stal chromowana / glass, electroplated steel, /
стекло, хромированная сталь

8171 ● CH



PICASSO LED 8131 CH

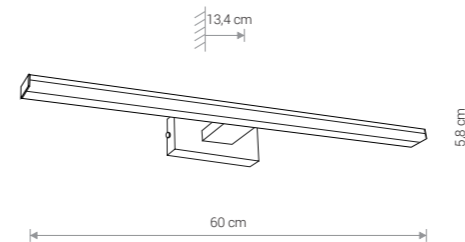

PICASSO LED

aluminium, PC / aluminium, PC / алюминий, PC

8131 ● CH



ION LED L 8172 CH

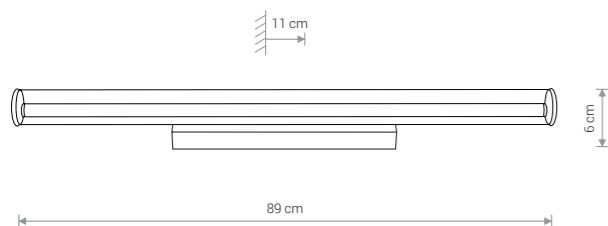

ION LED L

szkło, stal chromowana / glass, electroplated steel /
стекло, хромированная сталь

8172 ● CH



LATH LED 8175 CH

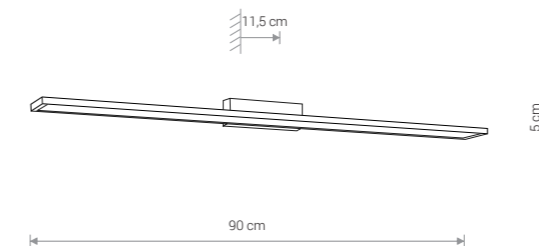

LATH LED

stal chromowana, PC / electroplated steel, PC /
хромированная сталь, PC

8175 ● CH

Item No.	POWER	COLOUR TEMP.	LUMINOUS FLUX	BEAM ANGLE	COLOUR RENDERING INDEX (CRI ≥)	INPUT	POWER FACTOR	SAFETY CLASS	INGRESS PROTECTION	LIFETIME
8171	12W	3000K	1000 lm	120°	80	~220-230V, 50/60Hz	0,5	⊕	IP20	30 000h
8172	18W	3000K	1400 lm	120°	80	~220-230V, 50/60Hz	0,5	⊕	IP20	30 000h

Item No.	POWER	COLOUR TEMP.	LUMINOUS FLUX	BEAM ANGLE	COLOUR RENDERING INDEX (CRI ≥)	INPUT	POWER FACTOR	SAFETY CLASS	INGRESS PROTECTION	LIFETIME
8131	12W	4000K	900 lm	120°	80	~220-230V, 50/60Hz	0,5	⊕	IP44	30 000h
8175	16W	4000K	430 lm	120°	80	~220-230V, 50/60Hz	0,5	⊕	IP44	20 000h



ICE TUBE LED S 8121 CH



ICE TUBE LED M 8122 CH



ICE TUBE LED S 8118 CH



ICE TUBE LED M 8120 CH

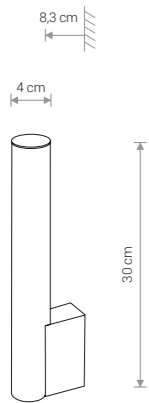

ICE TUBE LED S

PC, stal chromowana / PC, electroplated steel /
PC, хромированная сталь

8121 ● CH

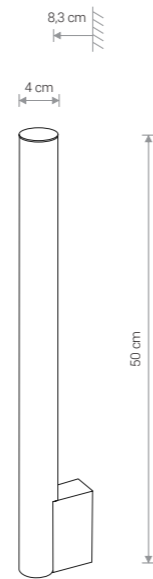

ICE TUBE LED M

PC, stal chromowana / PC, electroplated steel /
PC, хромированная сталь

8122 ● CH

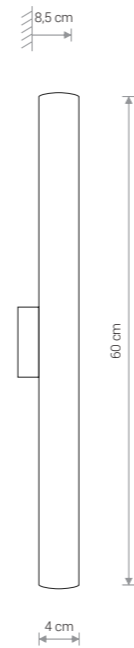

ICE TUBE LED S

PC, stal chromowana / PC, electroplated steel /
PC, хромированная сталь

8118 ● CH

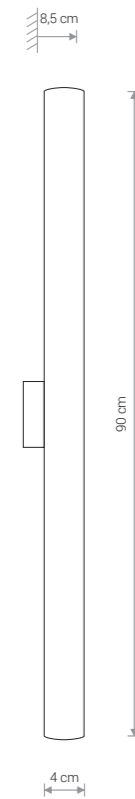

ICE TUBE LED M

PC, stal chromowana / PC, electroplated steel /
PC, хромированная сталь

8120 ● CH

Item No.	POWER	COLOUR TEMP.	LUMINOUS FLUX	BEAM ANGLE	COLOUR RENDERING INDEX (CRI ≥)	INPUT	POWER FACTOR	SAFETY CLASS	INGRESS PROTECTION	LIFETIME
8121	5W	4000K	380 lm	120°	80	~220-230V, 50/60Hz	0,5	□	IP44	30 000h
8122	8W	4000K	630 lm	120°	80	~220-230V, 50/60Hz	0,5	□	IP44	30 000h

Item No.	POWER	COLOUR TEMP.	LUMINOUS FLUX	BEAM ANGLE	COLOUR RENDERING INDEX (CRI ≥)	INPUT	POWER FACTOR	SAFETY CLASS	INGRESS PROTECTION	LIFETIME
8118	12W	4000K	1100 lm	120°	80	~220-230V, 50/60Hz	0,9	□	IP44	30 000h
8120	18W	4000K	1700 lm	120°	80	~220-230V, 50/60Hz	0,9	□	IP44	30 000h

VISTA 8051 CH

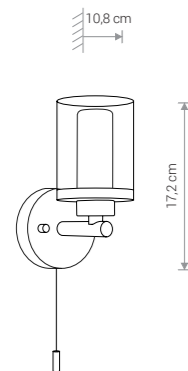

VISTA

stal chromowana, szkło / electroplated steel, glass, /
хромированная сталь, стекло

8051 ● CH

1×G9, max 10W, only LED

IP44

VISTA 8050 CH

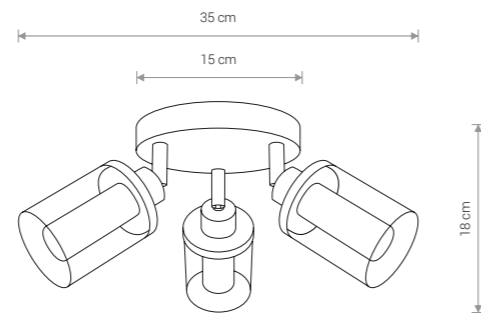

VISTA

stal chromowana, szkło / electroplated steel, glass, /
хромированная сталь, стекло

8050 ● CH

3×G9, max 10W, only LED

IP44

PAN LED S 8173 CH

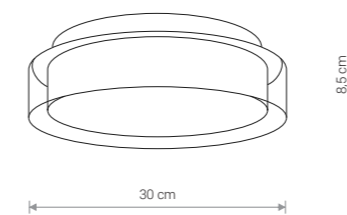

PAN LED S

szkło, stal chromowana / glass, electroplated steel /
стекло, хромированная сталь

8173 ● CH

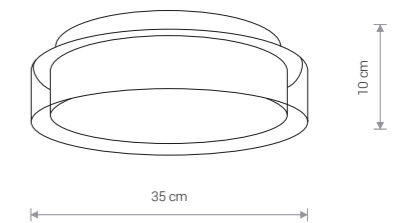

PAN LED M 8174 CH

PAN LED M

szkło, stal chromowana / glass, electroplated steel /
стекло, хромированная сталь

8174 ● CH

Item No.	POWER	COLOUR TEMP.	LUMINOUS FLUX	BEAM ANGLE	COLOUR RENDERING INDEX (CRI ≥)	INPUT	POWER FACTOR	SAFETY CLASS	INGRESS PROTECTION	LIFETIME
8173	12W	4000K	530 lm	120°	80	~220-230V, 50/60Hz	0,5	⊕	IP44	20 000h
8174	17W	4000K	800 lm	120°	80	~220-230V, 50/60Hz	0,5	⊕	IP44	20 000h



AGNES ROUND LED 8186 WH

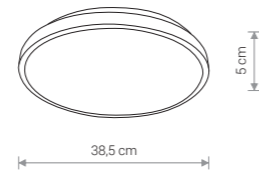

AGNES ROUND LED

stal lakierowana, PMMA / steel painted, PMMA /
лакированная сталь, PMMA

8207 ○ WH - 3000K 8204 ● BL - 3000K
8186 ○ WH - 4000K 8183 ● BL - 4000K



AGNES SQUARE LED 8138 BL

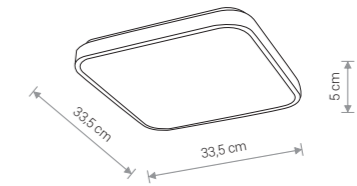

AGNES SQUARE LED

stal lakierowana, PMMA / steel painted, PMMA /
лакированная сталь, PMMA

8112 ○ WH - 3000K 8108 ● BL - 3000K
8135 ○ WH - 4000K 8138 ● BL - 4000K



AGNES ROUND LED 8187 WH

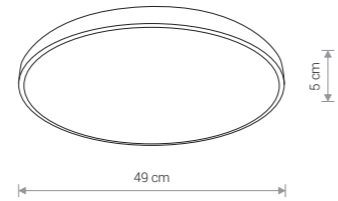

AGNES ROUND LED

stal lakierowana, PMMA / steel painted, PMMA /
лакированная сталь, PMMA

8208 ○ WH - 3000K 8205 ● BL - 3000K
8187 ○ WH - 4000K 8184 ● BL - 4000K



AGNES SQUARE LED 8137 BL

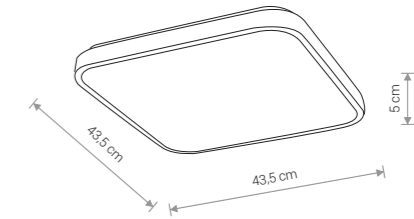

AGNES SQUARE LED

stal lakierowana, PMMA / steel painted, PMMA /
лакированная сталь, PMMA

8113 ○ WH - 3000K 8110 ● BL - 3000K
8134 ○ WH - 4000K 8137 ● BL - 4000K



AGNES ROUND LED 8188 WH

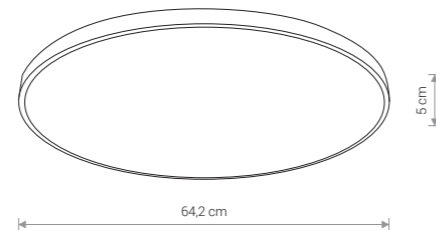

AGNES ROUND LED

stal lakierowana, PMMA / steel painted, PMMA /
лакированная сталь, PMMA

8210 ○ WH - 3000K 8206 ● BL - 3000K
8188 ○ WH - 4000K 8185 ● BL - 4000K



AGNES SQUARE LED 8133 WH

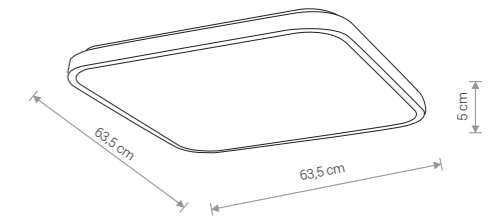

AGNES SQUARE LED

stal lakierowana, PMMA / steel painted, PMMA /
лакированная сталь, PMMA

8114 ○ WH - 3000K 8111 ● BL - 3000K
8133 ○ WH - 4000K 8136 ● BL - 4000K

Item No.	POWER	COLOUR TEMP.	LUMINOUS FLUX	BEAM ANGLE	COLOUR RENDERING INDEX (CRI ≥)	INPUT	SAFETY TYPE	INGRESS PROTECTION	LIFETIME
8207, 8204	22W	3000K	2000 lm	120°	80	~220-230V, 50/60Hz	⊕	IP44	20 000h
8186, 8183	22W	4000K	2000 lm	120°	80	~220-230V, 50/60Hz	⊕	IP44	20 000h
8208, 8205	32W	3000K	2900 lm	120°	80	~220-230V, 50/60Hz	⊕	IP44	20 000h
8187, 8184	32W	4000K	2900 lm	120°	80	~220-230V, 50/60Hz	⊕	IP44	20 000h
8210, 8206	64W	3000K	6000 lm	120°	80	~220-230V, 50/60Hz	⊕	IP44	20 000h
8188, 8185	64W	4000K	6000 lm	120°	80	~220-230V, 50/60Hz	⊕	IP44	20 000h

Item No.	POWER	COLOUR TEMP.	LUMINOUS FLUX	BEAM ANGLE	COLOUR RENDERING INDEX (CRI ≥)	INPUT	SAFETY TYPE	INGRESS PROTECTION	LIFETIME
8112, 8108	16W	3000K	1500 lm	120°	80	~220-230V, 50/60Hz	⊕	IP44	20 000h
8135, 8138	16W	4000K	1500 lm	120°	80	~220-230V, 50/60Hz	⊕	IP44	20 000h
8113, 8110	32W	3000K	2900 lm	120°	80	~220-230V, 50/60Hz	⊕	IP44	20 000h
8134, 8137	32W	4000K	2900 lm	120°	80	~220-230V, 50/60Hz	⊕	IP44	20 000h
8114, 8111	64W	3000K	6000 lm	120°	80	~220-230V, 50/60Hz	⊕	IP44	20 000h
8133, 8136	64W	4000K	6000 lm	120°	80	~220-230V, 50/60Hz	⊕	IP44	20 000h



BRAVO 8365 BL



BRAVO 8364 WH

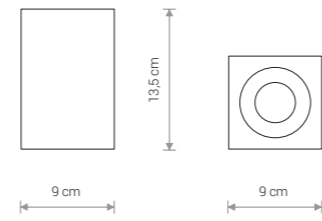

BRAVO

aluminium, szkło / aluminium, glass /
алюминий, стекло

8364 ○ WH 8365 ● BL

1×GU10, max 15W, only LED

IP54



ALPHA 8363 BL



ALPHA 8362 WH

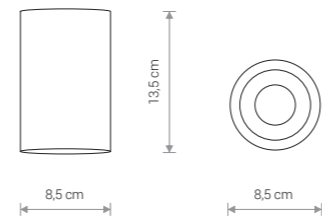

ALPHA

aluminium, szkło / aluminium, glass /
алюминий, стекло

8362 ○ WH 8363 ● BL

1×GU10, max 15W, only LED

IP54



ALPHA
8363 BL



FOXTROT
8373 WH

CHARLIE 8367 BL

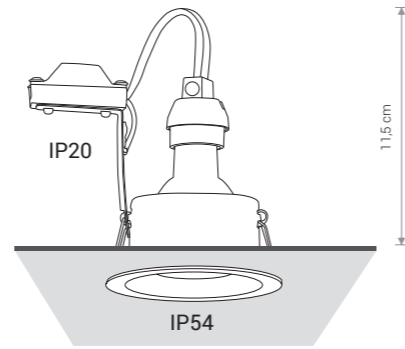
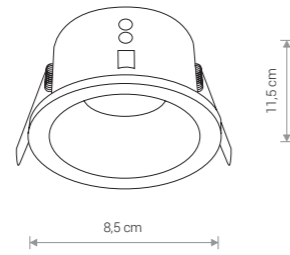

cut out ø 7,5 cm

CHARLIE

aluminium, szkło / aluminium, glass /
алюминий, стекло

8366 ○ WH 8367 ● BL

1×GU10, max 15W, only LED

IP54 / IP20

CHARLIE 8366 WH



GOLF 8376 BL

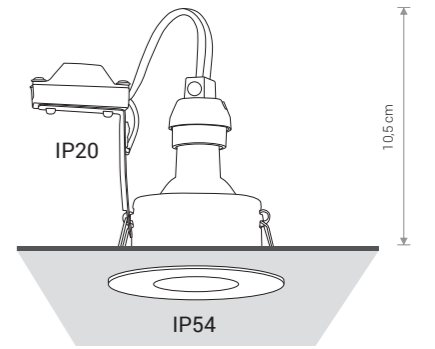
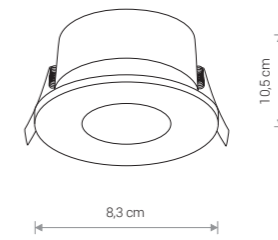

cut out ø 6,8 cm

GOLF

aluminium, szkło / aluminium, glass /
алюминий, стекло

8375 ○ WH 8376 ● BL

1×GU10, max 15W, only LED

IP54 / IP20

GOLF 8375 WH



DELTA 8370 BL

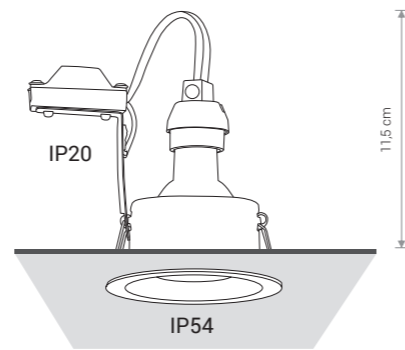
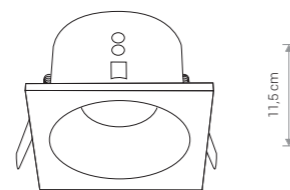

cut out ø 7,5 cm

DELTA

aluminium, szkło / aluminium, glass /
алюминий, стекло

8368 ○ WH 8370 ● BL

1×GU10, max 15W, only LED

IP54 / IP20

DELTA 8368 WH



ECHO 8372 BL

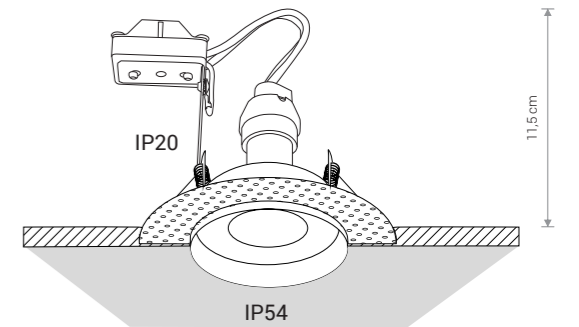
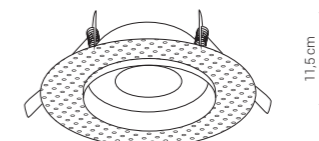

cut out ø 8 cm

ECHO

stal, szkło / steel, glass /
стали, стекло

8371 ○ WH 8372 ● BL

1×GU10, max 15W, only LED

IP54 / IP20

ECHO 8371 WH





FOXTROT 8373 WH

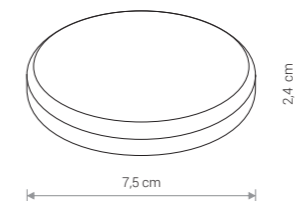

BULB GX53 LED 8W

PC / PC / PC

8377 ○ WH - 3000K

8378 ○ WH - 4000K



FOXTROT 8374 BL

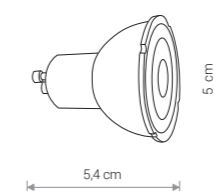

REFLECTOR GU10, R50, LED 7W

tworzywo sztuczne / thermal plastic / пластик

8348 ● BL - 3000K

8347 ● BL - 4000K



ZESTAW ZAWIERA 4 KOLOROWE NAKŁADKI.
THE SET INCLUDES FOUR COLOURED RINGS.
В КОМПЛЕКТЕ 4 ЦВЕТНЫЕ НАКЛАДКИ

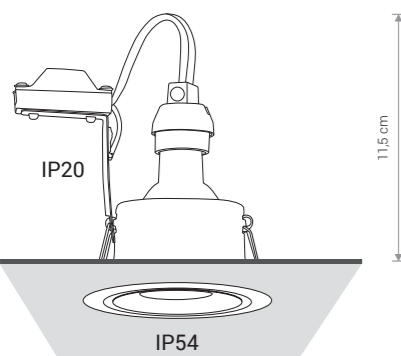

11,5 cm

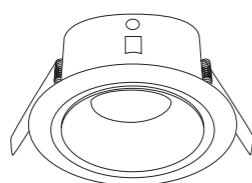

9,8 cm

cut out ø 8,5 cm

FOXTROT

aluminium, szkło / aluminium, glass / алюминий, стекло

8373 ○ WH 8374 ● BL

1×GU10, max 15W, only LED

IP54 / IP20

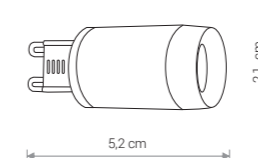

BULB G9 LED LENS 3W

ceramika, PC / ceramic housing, PC / PC

8447 ○ WH - 4000K

Item No.	POWER	COLOUR TEMP.	LUMINOUS FLUX	BEAM ANGLE	COLOUR RENDERING INDEX (CRI ≥)	INPUT	POWER FACTOR	LIFETIME
8377	8W	3000K	600 lm	120°	80	~220-230V, 50/60Hz	0,5	25 000h
8378	8W	4000K	600 lm	120°	80	~220-230V, 50/60Hz	0,5	25 000h
8348	7W	3000K	500 lm	36°	80	~220-230V, 50/60Hz	0,5	25 000h
8347	7W	4000K	500 lm	36°	80	~220-230V, 50/60Hz	0,5	25 000h
8447	3W	4000K	280 lm	120°	80	~220-230V, 50/60Hz	0,5	25 000h



STRUCTURE LED
8146 BL

STRUCTURE LED
8145 BL

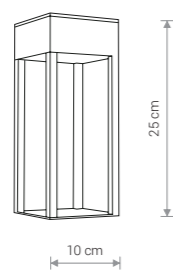

STRUCTURE LED

aluminium, PC / aluminium, PC / алюминий, PC

8146 ● BL

STRUCTURE LED 8146 BL

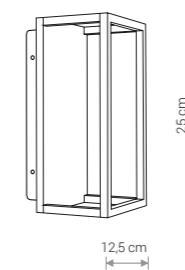

SYMMETRY LED

aluminium / aluminium / алюминий

8176 ● GR

SYMMETRY LED 8176 GR

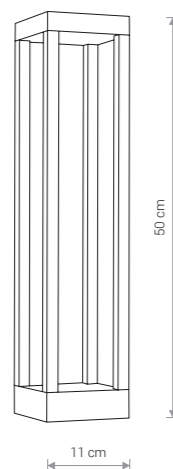

STRUCTURE LED

aluminium, PC / aluminium, PC / алюминий, PC

8145 ● BL

STRUCTURE LED 8145 BL

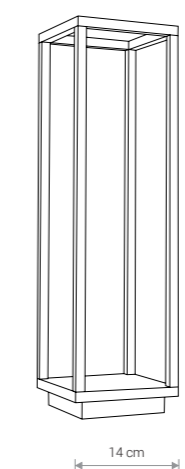

SYMMETRY LED

aluminium / aluminium / алюминий

8180 ● GR

SYMMETRY LED 8180 GR

Item No.	POWER	COLOUR TEMP.	LUMINOUS FLUX	BEAM ANGLE	COLOUR RENDERING INDEX (CRI ≥)	INPUT	POWER FACTOR	SAFETY CLASS	INGRESS PROTECTION	LIFETIME
8145	13W	3000K	820 lm	120°	80	~220-230V, 50/60Hz	0,9	⊕	IP54	20 000h
8146	13W	3000K	820 lm	120°	80	~220-230V, 50/60Hz	0,9	⊕	IP54	20 000h

Item No.	POWER	COLOUR TEMP.	LUMINOUS FLUX	BEAM ANGLE	COLOUR RENDERING INDEX (CRI ≥)	INPUT	POWER FACTOR	SAFETY CLASS	INGRESS PROTECTION	LIFETIME
8176	7W	3000K	212 lm	67°	85	~220-230V, 50/60Hz	0,5	⊕	IP54	30 000h
8180	7W	3000K	388 lm	66°	85	~220-230V, 50/60Hz	0,85	⊕	IP54	30 000h



HANGING SET FOR PICNIC
8107 WH



HANGING SET FOR PICNIC
8106 GR

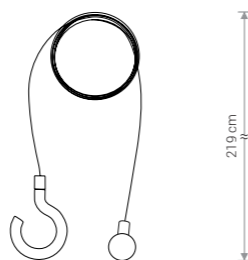

PICNIC LED 8178 WH



PICNIC LED 8177 GR



IP20

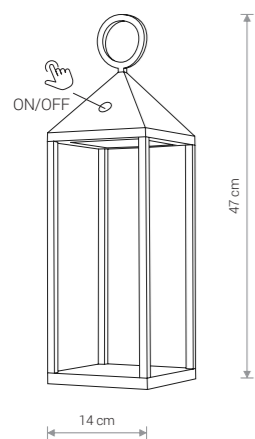

PICNIC LED

aluminium / aluminum / алюминий

8178 ○ WH 8177 ● GR

HANGING SET FOR PICNIC

aluminium, stal / aluminum, steel / алюминий, стали

8107 ○ WH 8106 ● GR

Lampa bezprzewodowa, przenośna, zewnętrzna

- Podstawa ładowująca w komplecie
- Akumulator litowy 2x2200 mAh
- Czas pełnego ładowania 5-8 h
- Czas pracy 12 h
- Włącznik dotykowy
- Ściemniacz

Wireless lamp, portable, outdoor

- Charging base (set incl.)
- 2x2200 mAh lithium battery
- Full charge time 5-8h
- Work time 12 h
- Touch switch
- Dimmable

Беспроводный светильник, переносной, уличный

- База для зарядки в комплекте
- Литиевая батарея 2x2200 mAh
- Время полной зарядки 5-8 ч
- Рабочее время 12 ч
- Сенсорный выключатель
- Диммер

Item No.	POWER	COLOUR TEMP.	LUMINOUS FLUX	BEAM ANGLE	COLOUR RENDERING INDEX (CRI ≥)	INPUT	SAFETY CLASS	INGRESS PROTECTION	LIFETIME
8177	2,2W	3000K	155 lm	46°	84	DC 3,7V	□	IP54/IP20	30 000h
8178	2,2W	3000K	155 lm	46°	84	DC 3,7V	□	IP54/IP20	30 000h





MAHE LED BLACK
8398 BL



MICRO USB

MAHE LED WHITE 8397 WH

MICRO USB

MAHE LED BLACK 8398 BL

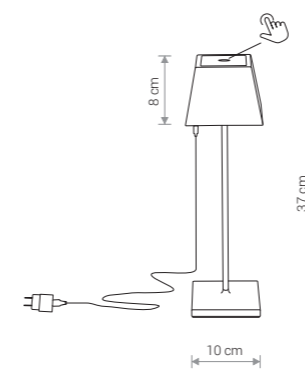

MAHE LED

aluminium, tworzywo sztuczne /
aluminium, plastic / алюминий, пластики

8397 ○ WH 8398 ● BL

Lampa bezprzewodowa, przenośna, zewnętrzna

- Ładowarka MICRO USB (w zestawie)
- Czas pełnego ładowania 5-7 h
- Czas pracy 9 h
- Włącznik dotykowy
- Ściemniacz

Wireless lamp, portable, outdoor

- Power adapter MICRO USB (set incl.)
- Full charge time 5-7 h
- Work time 9 h
- Touch switch
- Dimmable

Беспроводный светильник, переносной, уличный

- Зарядное устройство MICRO USB (в наборе)
- Время полной зарядки 5-7 ч
- Рабочее время 9 ч
- Сенсорный выключатель
- Диммер

Item No.	POWER	COLOUR TEMP.	LUMINOUS FLUX	BEAM ANGLE	COLOUR RENDERING INDEX (CRI ≥)	INPUT	SAFETY TYPE	INGRESS PROTECTION	LIFETIME
8398	2,2W LED	3000K	168 lm	46°	84	DC 3.7V	☐	IP54	25 000h
8397	2,2W LED	3000K	168 lm	46°	84	DC 3.7V	☐	IP54	25 000h

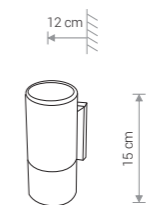

EXE

aluminium, szkło / aluminium, glass /
алюминий, стекло

8331 ● BL

1×GU10, max 35W

IP54

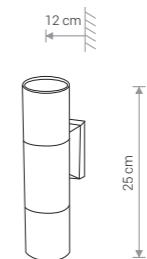

EXE

aluminium, szkło / aluminium, glass /
алюминий, стекло

8330 ● BL

2×GU10, max 35W

IP54

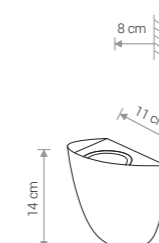

SINUS

aluminium, szkło / aluminium, glass /
алюминий, стекло

8144 ● BL

1×GU10, max 35W

IP54



ELLIPSES LED 8140 WH



ELLIPSES LED 8182 BL



ELLIPSES LED 8181 BL/G

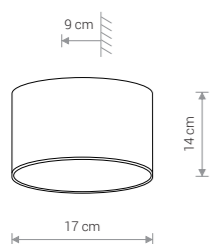

ELLIPSES LED

aluminium / aluminum / алюминий

8181  BL/G 8182  BL 8140  WH

Item No.	POWER	COLOUR TEMP.	LUMINOUS FLUX	BEAM ANGLE	COLOUR RENDERING INDEX (CRI ≥)	INPUT	POWER FACTOR	SAFETY CLASS	INGRESS PROTECTION	LIFETIME
8181	2x5W	3000K	600 lm	180°	90	~220-230V, 50/60Hz	0,5	⊕	IP54	10 000h
8182	2x5W	3000K	600 lm	180°	90	~220-230V, 50/60Hz	0,5	⊕	IP54	10 000h
8140	2x5W	3000K	600 lm	180°	90	~220-230V, 50/60Hz	0,5	⊕	IP54	10 000h

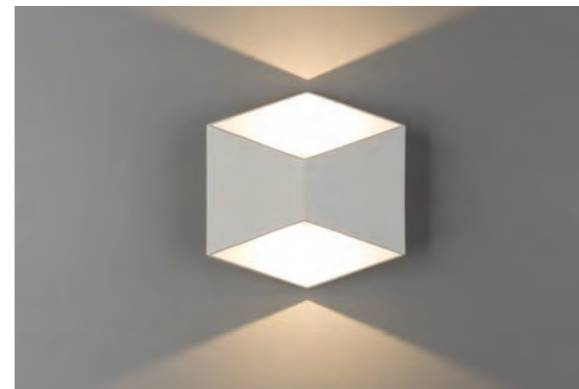

TRIANGLES LED 8143 WH

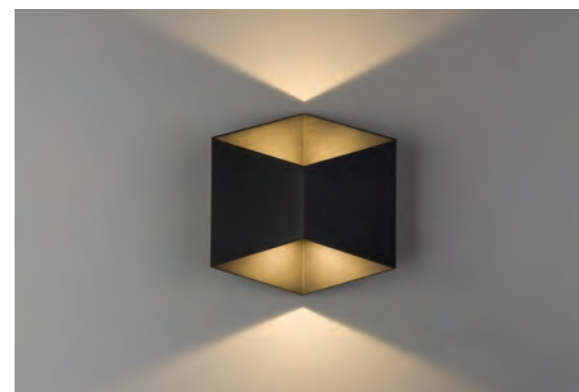

TRIANGLES LED 8142 BL

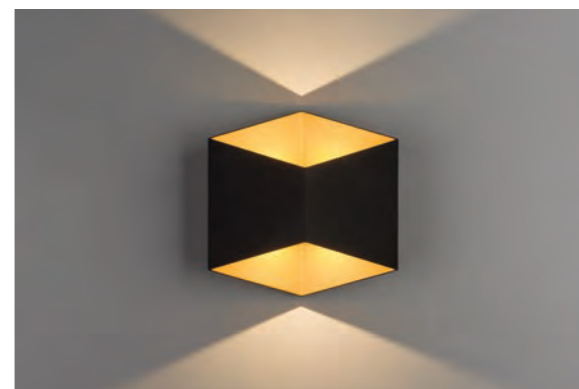

TRIANGLES LED 8141 BL/G

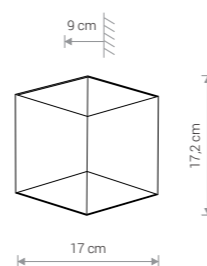

TRIANGLES LED

aluminium / aluminum / алюминий

8141  BL/G 8142  BL 8143  WH

Item No.	POWER	COLOUR TEMP.	LUMINOUS FLUX	BEAM ANGLE	COLOUR RENDERING INDEX (CRI ≥)	INPUT	POWER FACTOR	SAFETY CLASS	INGRESS PROTECTION	LIFETIME
8141	2x5W	3000K	450 lm	180°	90	~220-230V, 50/60Hz	0,5	⊕	IP54	10 000h
8142	2x5W	3000K	450 lm	180°	90	~220-230V, 50/60Hz	0,5	⊕	IP54	10 000h
8143	2x5W	3000K	450 lm	180°	90	~220-230V, 50/60Hz	0,5	⊕	IP54	10 000h

TUBINGS 8160 BL

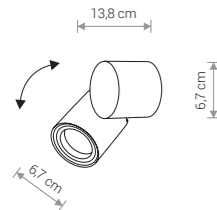

TUBINGS

aluminium, szkło / aluminum, glass / алюминий, стекло

8160 ● BL

1xGU10, max 35W

IP54

TUBINGS 8161 BL

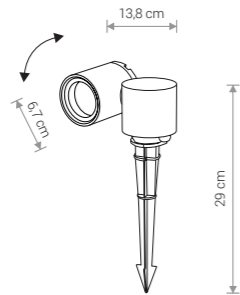

TUBINGS

aluminium, szkło / aluminum, glass / алюминий, стекло

8161 ● BL

1xGU10, max 35W

IP54

TUBINGS 8158 BL

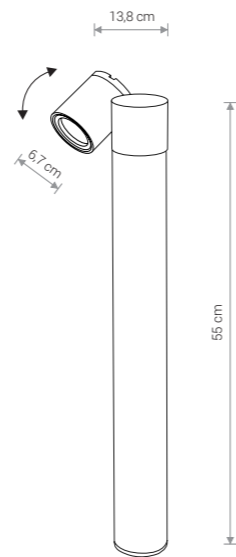

TUBINGS

aluminium, szkło / aluminum, glass / алюминий, стекло

8158 ● BL

1xGU10, max 35W

IP54



PAT LED 8162 BL

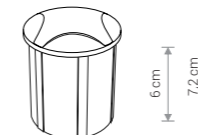

cut out ø 5,6 cm



PAT LED

aluminium, PC / aluminium, PC / алюминий, PC

8162 ● BL

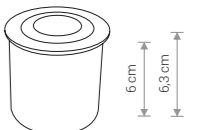

cut out ø 5,7 cm

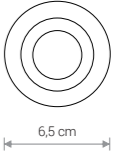

CIRCLET LED

aluminium, PC / aluminium, PC / алюминий, PC

8163 ● BL

Item No.	POWER	COLOUR TEMP.	LUMINOUS FLUX	BEAM ANGLE	COLOUR RENDERING INDEX (CRI ≥)	INPUT	POWER FACTOR	SAFETY CLASS	INGRESS PROTECTION	LIFETIME
8162	3W	3000K	12 lm	25°	80	~220-230V, 50/60Hz	0,5	⊕	IP65	10 000h
8163	3W	3000K	120 lm	120°	80	~220-230V, 50/60Hz	0,5	⊕	IP65	10 000h

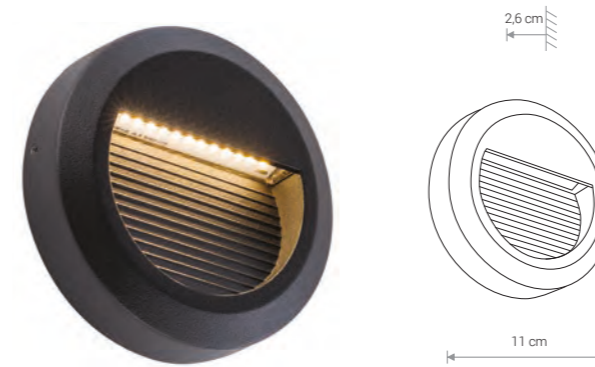

SIDEWALK ROUND LED

aluminium, PC / aluminium, PC / алюминий, PC

8147 ● BL

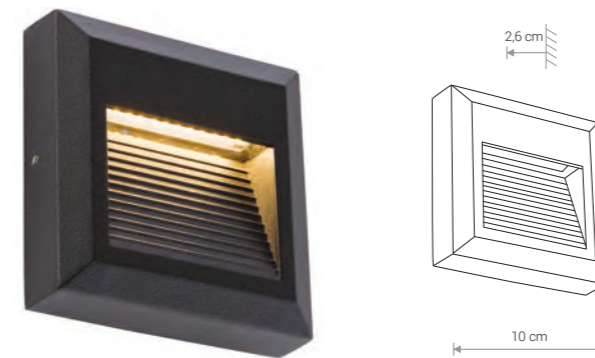

SIDEWALK SQUARE LED

aluminium, PC / aluminium, PC / алюминий, PC

8148 ● BL

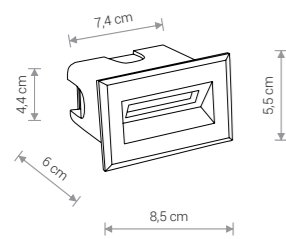

BAY LED S

aluminium, PC / aluminium, PC / алюминий, PC

8164 ● BL

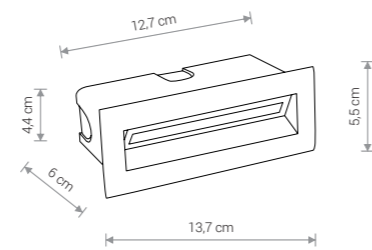

BAY LED M

aluminium, PC / aluminium, PC / алюминий, PC

8165 ● BL

Item No.	POWER	COLOUR TEMP.	LUMINOUS FLUX	BEAM ANGLE	COLOUR RENDERING INDEX (CRI ≥)	INPUT	POWER FACTOR	SAFETY CLASS	INGRESS PROTECTION	LIFETIME
8164	3W	3000K	220 lm	54°	80	~220-230V, 50/60Hz	0,5	⊕	IP65	10 000h
8165	5W	3000K	380 lm	51°	80	~220-230V, 50/60Hz	0,5	⊕	IP65	10 000h

Item No.	POWER	COLOUR TEMP.	LUMINOUS FLUX	BEAM ANGLE	COLOUR RENDERING INDEX (CRI ≥)	INPUT	POWER FACTOR	SAFETY CLASS	INGRESS PROTECTION	LIFETIME
8147	1,6W	3000K	61 lm	120°	80	~220-230V, 50/60Hz	0,5	⊕	IP54	20 000h
8148	1,6W	3000K	61 lm	120°	80	~220-230V, 50/60Hz	0,5	⊕	IP54	20 000h

A	FLEX CONNECTOR.....	41
	FOXTROT.....	74
	G	
AGNES ROUND LED.....	GIOTTO LED M.....	47
AGNES SQUARE LED.....	GIOTTO LED S.....	47
ALPHA.....	GOLF.....	73
AMALFI L.....	GSTAR.....	18
B	H	
BALI.....	HAMPTON.....	8
BARREL L.....	HANGING SET FOR PICNIC.....	80
BAY LED M.....	I	
BAY LED S.....	ICE BALL.....	52
BOSTON.....	ICE EGG A.....	57
BRAVO.....	ICE EGG B.....	57
BRAZOS.....	ICE EGG C.....	57
BULB G9 LED LENS 3W.....	ICE TUBE LED M.....	62
BULB GX53, LED 8W.....	ICE TUBE LED M.....	63
C	ICE TUBE LED S.....	62
CAYO.....	ICE TUBE LED S.....	63
CHARLIE.....	IMPULSE LED L.....	48
CHIC LED.....	IMPULSE LED M.....	48
CIRCLET LED.....	IMPULSE LED S.....	48
CONE L.....	ION LED L.....	60
CONE M.....	ION LED M.....	60
D	L	
DELTA.....	LASER 750.....	14
E	LASER 1000.....	15
ECHO.....	LATH LED.....	61
ELLIPSES LED.....	M	
EXE.....	MAHE LED.....	83
F		
FLEA.....		

N	R	
NEWPORT.....	REFLECTOR GU10, R50, LED 7W.....	75
NUNTUCET.....	REMBRANT LED L.....	46
O	REMBRANT LED M.....	46
ORGANIC.....	ROCKET.....	30
P	S	
PAN LED M.....	SIDEWALK ROUND LED.....	91
PAN LED S.....	SIDEWALK SQUARE LED.....	91
PAT LED.....	SIMI.....	55
PEAR L.....	SINUS.....	85
PEAR M.....	SIS.....	51
PEAR S.....	SMART LED.....	44
PETIT.....	STALACTITE.....	16
PETIT A.....	STRUCTURE LED.....	78
PETIT B.....	STYLE LED.....	42
PETIT C.....	SYMMETRY LED.....	79
PICASSO LED.....	T	
PICNIC LED.....	TORCH.....	58
PIN LED L.....	TRIANGLES LED.....	87
PIN LED M.....	TUBINGS.....	88
PIN LED S.....	V	
POINT TONE.....	VISTA.....	64
PROFILE FLEX CONNECTOR.....	W	
PROFILE RECESSED FLEX CONNECTOR.....	WHEEL LUX.....	20
PROFILE STORE PRO LED 7W.....		
PROFILE STORE PRO LED 12W.....		
PROFILE STORE PRO LED 18W.....		





















INDEKS LAMP / PROGRESSIVE CODE INDEX / ИНДЕКС СВЕТИЛЬНИКА

INDEX	STRONA PAGE СТРАНИЦА	INDEX	STRONA PAGE СТРАНИЦА	INDEX	STRONA PAGE СТРАНИЦА	INDEX	STRONA PAGE СТРАНИЦА
8050	64	8146	78	8207	66	8348	75
8051	64	8147	91	8208	66	8350	16
8052	55	8148	91	8210	66	8351	16
8053	54	8150	10	8220	35	8352	16
8054	51	8151	10	8221	35	8353	16
8055	50	8152	9	8222	35	8354	16
8056	55	8153	9	8223	35	8355	16
8057	55	8154	8	8224	35	8356	16
8106	80	8155	8	8225	35	8357	45
8107	80	8156	11	8226	29	8358	44
8108	67	8157	11	8285	18	8362	68
8110	67	8158	88	8302	33	8363	68
8111	67	8160	88	8303	33	8364	68
8112	67	8161	88	8304	33	8365	68
8113	67	8162	89	8305	33	8366	72
8114	67	8163	89	8315	37	8367	72
8115	48	8164	90	8316	37	8368	72
8116	48	8165	90	8317	37	8370	72
8117	48	8166	46	8318	37	8371	73
8118	63	8167	46	8320	38	8372	73
8120	63	8168	47	8321	38	8373	74
8121	62	8170	47	8322	38	8374	74
8122	62	8171	60	8323	38	8375	73
8123	58	8172	60	8324	39	8376	73
8124	57	8173	65	8325	39	8377	75
8125	57	8174	65	8326	39	8378	75
8126	52	8175	61	8327	39	8380	7
8127	49	8176	79	8330	85	8381	7
8128	49	8177	80	8331	85	8382	40
8130	49	8178	80	8332	29	8383	40
8131	61	8180	79	8333	29	8384	41
8132	57	8181	86	8334	29	8385	41
8133	67	8182	86	8335	29	8397	83
8134	67	8183	66	8336	29	8398	83
8135	67	8184	66	8337	29	8404	42
8136	67	8185	66	8338	29	8427	20
8137	67	8186	66	8340	29	8428	20
8138	67	8187	66	8341	29	8430	20
8140	86	8188	66	8342	29	8431	14
8141	87	8202	34	8343	29	8432	14
8142	87	8203	34	8344	29	8433	14
8143	87	8204	66	8345	28	8434	15
8144	85	8205	66	8346	28	8435	15
8145	78	8206	66	8347	75	8436	15

INDEKS LAMP / PROGRESSIVE CODE INDEX / ИНДЕКС СВЕТИЛЬНИКА

INDEX	STRONA PAGE СТРАНИЦА	INDEX	STRONA PAGE СТРАНИЦА	INDEX	STRONA PAGE СТРАНИЦА	INDEX	STRONA PAGE СТРАНИЦА
8437	25	8442	24	8446	23	8671	5
8438	25	8443	24	8447	75	8672	4
8440	25	8444	23	8448	30	8673	4
8441	24	8445	23	8490	30	9055	16

KODY KOLORÓW / COLOUR CODES / ЦВЕТОВЫЕ КОДЫ

 WH - WHITE	 BL - BLACK	 GY - GRAY
 SI - SILVER	 G - GOLD	 BS - BRASS
 WH/G - WHITE/GOLD	 G/BL - GOLD/BLACK	 BS/BL - BRASS/BLACK
 TR/G - TRANSPARENT/GOLD	 V NB/G - VELVET NAVI BLUE/GOLD	 A/BS - ANTIQUE BRASS
 CH/WH - CHROME/WHITE	 V GN/G - VELVET GREEN/GOLD	 V WH - VELVET WHITE
 WH/SI - WHITE/SILVER	 V PI/WH - VELVET PINK/WHITE	 GR - GRAPHITE
 BL/SI - BLACK/SILVER	 CH - CHROME	 CH/TR - CHROME/TRANSPARENT





A series of horizontal dotted lines for writing notes.

A series of horizontal dotted lines for writing notes.

Nowodvorski

L I G H T I N G

 Nowodvorski sp.j.
ul. Bojemskiego 11
42-202 Częstochowa
POLAND

 +48 34 344 91 10 / 11
 +48 34 344 91 12
 nowodvorski@nowodvorski.com
 www.nowodvorski.com



Design & production
GRAFFITI
CREATIVE PEOPLE
www.graffiti.com.pl

Nowodvorski

L I G H T I N G

Nowodvorski sp.j.
ul. Bojemskiego 11
42-202 Częstochowa
POLAND



+48 34 344 91 10/11



nowodvorski@nowodvorski.com



www.nowodvorski.com